

The TH model knife gate valve is a bi-directional wafer type through-conduit high pressure valve designed for media with high consistency. The double seat design assures a non-clogging shut off on suspended solids in both flow directions. The valve is used in a wide range of demanding applications in industries such as Pulp & Paper, Wastewater Treatment Plants, Chemical Plants, Power Plants, etc.

Product description:

- Bi-directional wafer type through-conduit high pressure knife gate valve
- Size range of DN300-1000 (larger sizes upon request). See Dimension Charts for pressure rating
- Rising & non-rising stem configurations available
- Standard flange connection: DIN PN10 (EN 1092-2) and ANSI B16.5 (class 150)
Others available upon request
- Manual (handwheel, chainwheel, lever and bevel gear), pneumatic (single and double-acting), electric and hydraulic actuation options available
- For EU Directives and other Certificates, please see the document: Directives and Certificates Compliance - Knife Gate Valves - Catalogues and Datasheets

Features:

- Wafer type cast two-part bolted stainless steel body with internal HMWPE sliders for a smoother gate traveling
- Full port design for greater flow capacity and minimal pressure drop
- Stainless steel o-port design through-going gate, polished both sides to avoid jamming and seat damage
- Cast stainless steel seat ring, easily replaceable, that mechanically locks the seal. Standard EPDM seat, also available in other materials (PTFE,...). Metal-to-metal seat and deflection cones available
- Dual packing with easy access and adjustable packing glands. Long life multiple graphite imp. PTFE & aramid yarn combination with elastomeric core and EPDM o-ring. Wide range of materials available
- Automated valves provided with gate guards in accordance with EU Safety Standards
- Other options: bonnets, flush ports, special materials, fabricated valves, etc.
- Actuation accessories: limit & proximity switches, mechanical stops, positioners, solenoid valves, manual overrides, locking devices, fail safe systems, stem extensions and floor stands

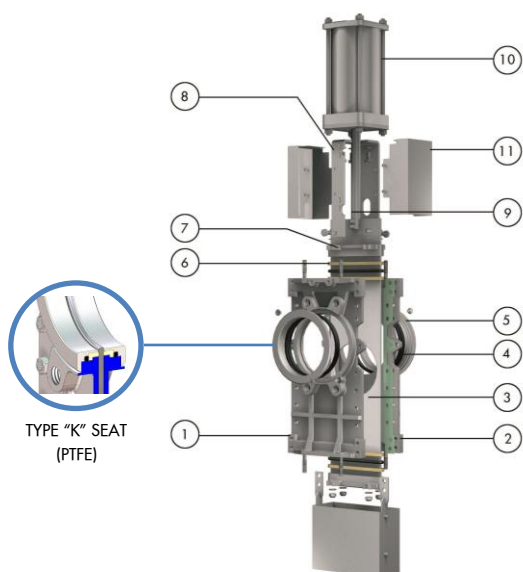

STANDARD PARTS LIST

Part	Stainless steel
1 Body	CF8M / AISI 316
2 Body	CF8M / AISI 316
3 Gate	AISI 316
4 Seat	PTFE
5 "K" ring	AISI 316
6 Packing	Dynapack + EPDM O-ring
7 Gland Follower	CF8M / AISI 316
8 Yoke	AISI 304 (1.4301)
9 Piston Rod	AISI 304 (1.4301)
10 Cylinder	Aluminum
11 Gate Guards	AISI 304 (1.4301)

DIMENSIONS (mm) Bevel Gear Non Rising Stem

DN	Pressures	X	A	B	D	J	K	ØG	H	O max.
300	10 bar	302	78	410	280	810	420	310	822	905
350	10 bar	332	78	473	300	900	490	410	897	1047
400	10 bar	380	89	538	350	1000	540	410	997	1171
450	10 bar	420	89	588	420	1125	595	550	1120	1301
500	10 bar	490	114	740	490	1215	655	550	1210	1575
600	10 bar	540	122	754	530	1395	755	550	1389	1711
700	10 bar	665	128	860	650	1615	855	650	997	2005
800	10 bar	760	128	964	740	1805	955	650	1120	2295
900	6 bar	880	128	1070	845	2010	1055	650	1210	2585
1000	6 bar	970	128	1180	955	2220	1155	650	1389	2875

* For higher pressures, please contact ORBINOX

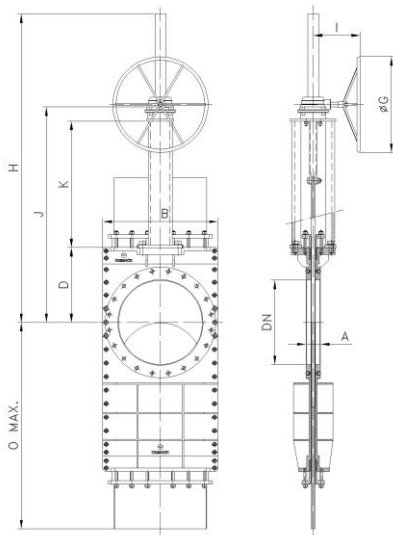
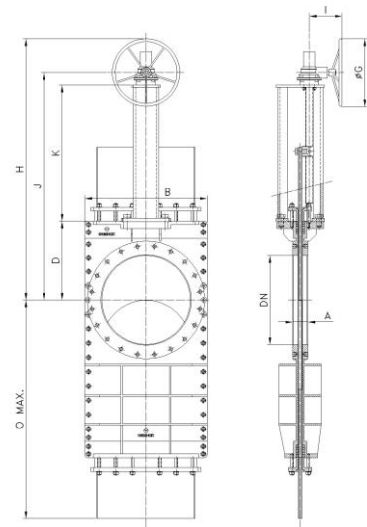

DIMENSIONS (mm) Bevel Gear Rising Stem

DN	Pressures	X	A	B	D	J	K	ØG	H	O max.
300	10 bar	302	78	410	280	810	420	310	1102	905
350	10 bar	332	78	473	300	900	490	410	1286	1047
400	10 bar	380	89	538	350	1000	540	410	1386	1171
450	10 bar	420	89	588	420	1125	655	550	1583	1301
500	10 bar	490	114	740	490	1395	755	550	1673	1575
600	10 bar	540	122	754	530	1615	855	550	1963	1711
700	10 bar	665	128	860	650	1615	855	650	2300	2005
800	10 bar	760	128	964	740	1805	955	650	2640	2295
900	6 bar	880	128	1070	845	2010	1055	650	2980	2585
1000	6 bar	970	128	1180	955	2220	1155	650	3310	2875

* For higher pressures, please contact ORBINOX

DIMENSIONS (mm) Pneumatic Actuator (D/A)

DN	Pressures	X	A	B	D	O max.	E	F	G	H	Standard Cyl.	Connect.
300	10 bar	302	78	410	280	905	414	478	220	1172	C200/320	3/8" G
350	10 bar	332	78	473	300	1047	510	535	277	1344	C200/375	3/8" G
400	10 bar	380	89	538	350	1171	560	585	277	1494	C250/425	3/8" G
450	10 bar	420	89	588	420	1301	608	665	382	1693	C250/475	1/2" G
500	10 bar	490	114	740	490	1575	754	715	382	1959	C300/525	1/2" G
600	10 bar	540	122	754	530	1711	796	880	444	2206	C350/625	3/4" G
700	10 bar	665	128	960	650	1820	855	980	444	2485	C350/725	3/4" G
800	10 bar	760	128	964	740	1930	955	1080	444	2775	C350/825	3/4" G
900	6 bar	880	128	1070	845	2040	1055	1180	444	3080	C400/925	3/4" G
1000	6 bar	970	128	1180	955	2135	1155	1280	444	3390	C400/1025	3/4" G

* For higher pressures, please contact ORBINOX

